

# Tel-O-Graph<sup>®</sup> GSM

Operating manual

EN



**IEM<sup>®</sup>**

**Tel-O-Graph® GSM**  
**Blood pressure monitor**



IEM GmbH  
Cockerillstr. 69  
52222 Stolberg  
Germany

Telephone: +49 2402 9500-0  
Fax: +49 2402 9500-11  
E-mail: [info@iem.de](mailto:info@iem.de)  
Website: [www.iem.de](http://www.iem.de)

The content of this operating manual must not be reproduced or published without the written approval of IEM GmbH.

© IEM GmbH 2019. All rights reserved.

**Table of contents**

<b>Table of contents</b> .....	<b>3</b>
<b>1 Introduction</b> .....	<b>4</b>
1.1 Clinical validation .....	5
1.2 CE Mark .....	5
1.3 Contents .....	5
<b>2 Instructions for use</b> .....	<b>6</b>
2.1 Intended use .....	6
2.2 Improper use.....	6
2.3 Essential Performance .....	7
<b>3 Safety</b> .....	<b>8</b>
3.1 Explanation of the safety symbols.....	8
3.2 Important patient information.....	9
3.3 Important device instructions.....	12
<b>4 Description of device</b> .....	<b>15</b>
4.1 Blood pressure monitor .....	15
4.2 Blood pressure cuff.....	16
4.3 Display .....	17
4.4 Ambient conditions .....	18
<b>5 Preparing the measurement</b> .....	<b>19</b>
5.1 Unpacking.....	19
5.2 Inserting the batteries .....	19
5.3 Switching the blood pressure monitor on/off ..	21

<b>6 Measuring blood pressure and pulse</b> .....	<b>22</b>
6.1 Before measuring .....	22
6.2 Putting the blood pressure cuff on .....	22
6.3 Correct posture.....	25
6.4 Measuring .....	26
6.5 Stopping the measurement .....	27
<b>7 Transferring the measured values via mobile communications network</b> .....	<b>28</b>
<b>8 Memory</b> .....	<b>29</b>
8.1 Saving readings.....	29
8.2 Deleting readings from the blood pressure monitor.....	30
<b>9 Cleaning and disinfection</b> .....	<b>31</b>
9.1 Cleaning .....	31
9.2 Disinfection .....	33
<b>10 Maintenance</b> .....	<b>34</b>
<b>11 Disposal</b> .....	<b>35</b>
<b>12 Error messages</b> .....	<b>36</b>
12.1 Blood pressure measurement errors .....	36
12.2 Communication error.....	39
<b>13 Technical data and symbols</b> .....	<b>41</b>
<b>14 Warranty and repairs</b> .....	<b>45</b>
<b>15 Manufacturer's EMC guidelines</b> .....	<b>46</b>
<b>16 Frequency bands</b> .....	<b>50</b>

## *Introduction*

### **1 Introduction**

Thank you for choosing the Tel-O-Graph® GSM upper-arm blood pressure monitor.

Read this operating manual carefully before use and keep it in a suitable place so that the information is available when required.

Tel-O-Graph® GSM is a fully automated blood pressure and pulse monitor that enables automatic transmission by means of a mobile network.

This operating manual explains the blood pressure monitor and accessories in the order in which you will operate the monitor and also use later.

The Tel-O-Graph® GSM can be integrated in tele-monitoring systems that may involve different products for data transmission and storage. Such products, and the data base used to store and assess the blood pressure readings is not part of the Tel-O-Graph® GSM, but is within the responsibility of the care provider that you have allowed to monitor your blood pressure readings. You may not have direct access to the database, and need to contact the care provider, if you have any question related to the stored data.

If you have any questions about our services or products, feel free to contact us.

### 1.1 Clinical validation

The accuracy of the device's measurements has been certified in accordance with ISO 81060-2:2013.

### 1.2 CE Mark



The Tel-O-Graph® GSM meets the requirements of the

- 93/42/EEC (MDD),
- 2014/53/EU (RED),
- 2011/65/EU (RoHS) guidelines

and bears the CE mark.

IEM GmbH hereby declares that the Tel-O-Graph® GSM corresponds to the 2014/53/EU (RED) guideline.



#### External reference

The complete text of the EU declaration of conformity is available at the following website address:  
[www.iem.de](http://www.iem.de).

### 1.3 Contents

#### Contents

- Blood pressure monitor
- Blood pressure cuff "M"  
(Arm circumference: 24-32 cm (9.5-12.6 in))
- Operating manual
- Batteries (4x, AA, alkaline)

#### Optional accessories

- Blood pressure cuff "S"  
(Arm circumference: 20-24 cm (7.9-9,5 in))
- Blood pressure cuff "L"  
(Arm circumference: 32-38 cm (12.6-15.0 in))
- Blood pressure cuff "XL"  
(Arm circumference: 38-55 cm (15.0-21.7 in))

## Instructions for use

### 2 Instructions for use

#### 2.1 Intended use

The Tel-O-Graph® GSM is intended for the home measurement of blood pressure and pulse on the upper arm in adults.

The blood pressure monitor is suitable for individuals with an arm circumference of 20-55 cm (7.9-21.7 in) when used with the corresponding monitor cuff size.

The data measured is automatically transmitted.



#### **WARNING**

Self-diagnosis and self-treatment on the basis of the results is dangerous!

- Do not undertake any treatment and/or take medication as a result of the measured values without consulting your doctor.
- Follow your doctor's instructions.

#### 2.2 Improper use

The blood pressure monitor must not be used for newborns, during surgery, in the vicinity of MRI scanners or other strong magnetic fields, or for clinical monitoring of patients and during transport of patients. The blood pressure monitor must not be left within the reach of unsupervised children or be used by those with limited mental competencies.

It must not be used for any purpose other than the process of measuring blood pressure described herein.



#### **Note**

- The device has not been tested for use with pregnant women or those suffering from preeclampsia.
- If you are taking medication to alter blood clotting, consult your doctor before using the blood pressure monitor.

### 2.3 Essential Performance

The essential performance features are defined as blood pressure measurement with:

- Error tolerances of the pressure gauge and measurement results within the required limits according to IEC 80601-2-30.
- Maximum change value in blood pressure determination according to IEC 80601-2-30.
- Power delivery (pressure supply to the cuff) within the set limits according to IEC 80601-2-30, EN 1060-3
- An error is issued in the event that successful blood pressure measurement is impossible.

The blood pressure monitor does not emit an alarm in the sense of IEC 60601-1-8. The blood pressure monitor is not provided to be used in conjunction with RF surgery monitors or for the clinical monitoring of patients, such as on an intensive care unit.

Basic safety means that the patient cannot be endangered by any automatic device procedure.

In the event of an unclear status or state of the blood pressure monitor, the blood pressure monitor must enter standby mode by the device releasing the air in

the cuff. The cuff is not automatically pressurised, to do so, the device must be initiated manually.

## Safety

### 3 Safety

This section explains all the safety information for the device.

Read this section carefully before using the blood pressure monitor.

Contact your doctor before using the device if you are pregnant, are taking medication to alter blood clotting or if you have been diagnosed with cardiac arrhythmia, coagulation disorders or arteriosclerosis.

#### 3.1 Explanation of the safety symbols



#### **WARNING**

##### **Short description of the danger**

This warning symbol in connection with the signal word **WARNING** indicates a possible or immediately threatening danger.

Non-adherence may lead to the mild, moderate injuries or to the most severe injuries or death.



#### **ATTENTION**

##### **Short description of the danger**

This warning symbol, in connection with the signal word **ATTENTION**, indicates possible material damage.

Non-adherence may lead to damage to the products or their accessories.



#### **NOTE**

The signal word **Note** indicates further information about the Tel-O-Graph® GSM or its accessories.



#### **External reference**

Indicates reference to external documents in which further information may optionally be found.



### 3.2 Important patient information



#### WARNING

##### Danger as a result of self-diagnosis

- Do not undertake any changes to your treatment and/or take medication due to the measured values without consulting your doctor.
- Follow your doctor's instructions.



#### WARNING

##### Danger of blood flow disruptions as a result of putting on and pumping up a cuff on limbs with an intra-vascular drip or intra-vascular treatment or with an arteriovenous (AV) shunt.

- Do not put the Tel-O-Graph® GSM on when you have an intra-vascular drip or arteriovenous (AV) shunt in your arm.



#### WARNING

##### Danger of tissue bleeding or haematoma.

- When using the blood pressure monitor, make sure it does not impede the blood circulation in your arm.
- If you have sensitive bodily tissue, despite the correct positioning of the cuff, it can still result in tissue bleeding or haematoma.
- If you are taking medication to alter blood clotting or suffer from coagulation disorders, consult your doctor before using the blood pressure monitor.



#### WARNING

##### Danger of injury as a result of allergic reactions to the cuff material

- In the event of pain or allergic reactions, remove the cuff.
- Pay attention to hygiene concerns.



### WARNING

**Danger of injury as a result of using unapproved accessories**

- Only use accessories approved by the manufacturer and distributed by the trader or manufacturer.
- Read the respective information provided by the manufacturer before using the accessories for the first time.
- Before use, check accessories in relation to the manufacturer specifications.



### WARNING

**Danger of injury as a result of putting on or pumping up a cuff on an arm on the same side of the body as a mastectomy has been carried out**

- Do not put the Tel-O-Graph® GSM on an arm on the same side of the body as a mastectomy has been carried out.



### WARNING

**Danger of a temporary loss of function of a present electrical medical device as a result of putting on or pumping up a cuff if you are wearing a further electrical medical device for monitoring on the same limb.**

- Only put the Tel-O-Graph® GSM on if you are not wearing any other medical electrical monitor on your arm.



### WARNING

**Danger of fluid occurrence when using the batteries incorrectly**

- Liquid that escapes from the batteries due to mishandling can cause skin irritation. If you come into contact with the liquid, rinse it away with plenty of water. If the liquid comes into contact with your eyes, do not rub your eyes but instead immediately rinse them with water for 10 minutes and contact a doctor without delay.

**WARNING****Danger of blood flow interruptions as a result of steady cuff pressure or too frequent measuring**

- Ensure the cuff hose is in the correct position and take care that the cuff hose is not knotted, pinched, kinked or stretched.
- If you notice pain, swelling, reddening or numbness in your arm, around which the cuff is placed, inform your doctor. (It is expected that some mild to moderate discomfort may be experienced during a blood pressure measurement.)
- Measurement can be interrupted at any stage by pushing any button. This deflates the cuff and the cuff can be removed.

**WARNING****Danger of strangulation by the cuff hose**

- Persons (including children) who are unable to use the blood pressure monitor safely due to their physical, sensory or mental capabilities or their inexperience or lack of knowledge must not use this blood pressure monitor without supervision or instruction by a responsible person.
- The blood pressure monitor may not be used by those with limited mental competencies. (Keep out of reach.)
- Do not wrap the cuff or the cuff hose around your neck!
- The cuff must only be worn on the upper arm!
- Check the correct positioning of the cuff.
- If you notice pain, swelling, reddening or numbness in the arm around which the cuff is placed, inform your doctor. (It is expected that some mild to moderate discomfort may be experienced during a blood pressure measurement.)

## Safety

- Measurement can be interrupted at any stage by pressing the button. This deflates the cuff and the cuff can be removed.

### 3.3 Important device instructions



#### ATTENTION

##### Equipment failure

- The device must not be used in the vicinity of magnetic resonance imaging apparatus or in the direct proximity of another electrical medical monitor.
- The device is not suitable for simultaneous use with high frequency surgery monitors.
- Do not drop the blood pressure monitor and do not place objects on top of it.
- Do not use the device directly adjacent to other devices or stacked with other devices, as this may result in malfunction. If operation in the manner described above becomes necessary nevertheless, this device and the other devices should be monitored to ensure that they are functioning correctly
- Use of components other than those supplied with the device may result in measurement errors, as other equipment (e.g. transformers and cables) may cause increased electromagnetic interference or have reduced

electromagnetic immunity. You should therefore only use genuine IEM accessories.

- The cuff and the hose are made of a material that does not conduct electricity. They thus protect the device against the effects of discharging a defibrillator. In the event of discharging a defibrillator, the device itself must not touch the patient since the device can be damaged as a result of such a discharging and can result in the incorrect value being displayed.



#### ATTENTION

##### Warranty

- Do not open the housing of the Tel-O-Graphs® GSM, otherwise any warranty becomes void.



#### ATTENTION

##### Batteries

- Remove the batteries from the battery compartment when they no longer have any charge or if you do not expect to use the blood pressure monitor for a longer period of time.
- Do not throw batteries into fire and never expose them to high temperatures!
- Do not attempt to recharge the batteries. Do not attempt to open or short-circuit the batteries. There is a risk of explosion.



### ATTENTION

#### Electric fields

- Measurements may be faulty if the device is operated in the vicinity of strong electrical fields. Do not operate the blood pressure monitor near:
  - High-voltage power lines
  - Microwave devices
- Portable and mobile RF transmitters, such as mobile phones for example, may affect the blood pressure monitor. Transmission of data via mobile communication networks may be disrupted by other devices, even if those devices comply with the applicable transmission requirements specified by CISPR. You should therefore ensure that the Tel-O-Graphs® GSM is at least 30 cm (12 inches) from any portable RF communications equipment.



### ATTENTION

#### Fluid damage to the blood pressure monitor

- Liquid must not penetrate the device. If you believe that liquid has penetrated the device during cleaning or use of the blood pressure monitor, the device must no longer be used.
- If the blood pressure monitor is exposed to moisture, switch the blood pressure monitor off and remove the batteries. Immediately inform your healthcare provider.



#### Note

- This blood pressure monitor is intended for use in home healthcare environments and professional healthcare institutions, such as first aid facilities and hospitals.

## 4 Description of device

### 4.1 Blood pressure monitor

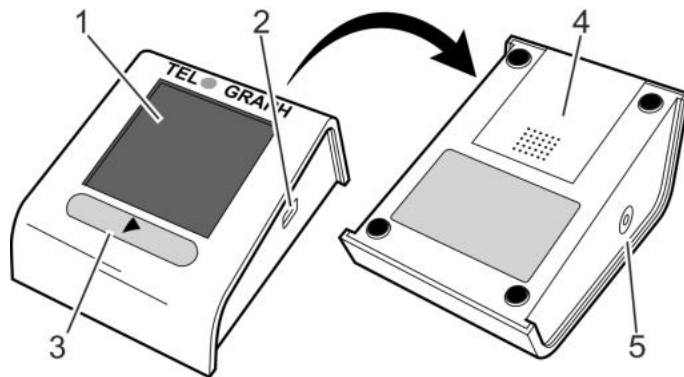

Fig. 1: Blood pressure monitor

1 Display

2 Infrared interface (for service)

3  button

4 Battery cover

5 Air hose socket

*Description of device*

**4.2 Blood pressure cuff**

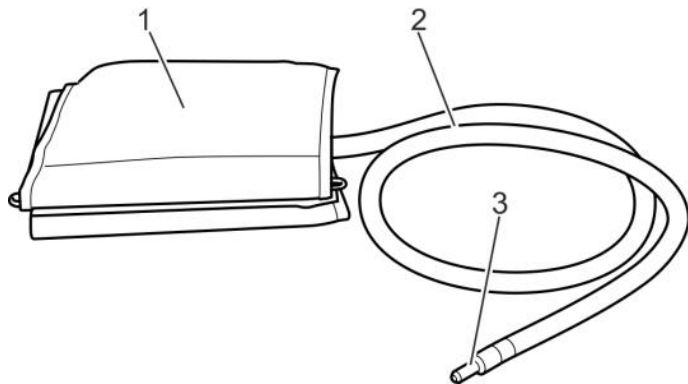

*Fig. 2: Blood pressure cuff*

- 1 Blood pressure cuff
- 2 Air hose
- 3 Air hose connection



## 4.3 Display

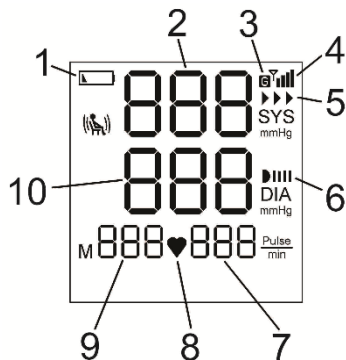

Fig. 3: Display

- |   |                                       |    |                                    |
|---|---------------------------------------|----|------------------------------------|
| 1 | When this appears: Battery empty      | 6  | Infra-red communication            |
| 2 | Display of systolic (upper) value     | 7  | Number of pulse beats per minutes  |
| 3 | Mobile network communication          | 8  | Pulse detected                     |
| 4 | Signal strength of the mobile network | 9  | Number of measurement values       |
| 5 | Data transmission                     | 10 | Display of diastolic (lower) value |

## *Description of device*

### **4.4 Ambient conditions**



#### **ATTENTION**

Extreme temperatures, humidity or air pressure can influence measurement accuracy. Please follow the operating instructions.

- Never store the blood pressure monitor outside a temperature range of -25 °C to +70 °C.
- Never use the blood pressure monitor outside a temperature range of +5 °C to +40 °C.
- Only store or use the blood pressure monitor at an air humidity (not condensing) of 15% to 93%.
- Extreme temperatures, air humidity (not condensing) or heights can affect the performance of the blood pressure monitor.

## 5 Preparing the measurement

### 5.1 Unpacking

#### ► Note

All parts included in delivery package have been properly packed and checked for completeness and functionality. Should the product be incomplete, damaged or defect, please inform your healthcare provider immediately.

#### ⚠ WARNING

Risk of strangulation from the cuff hose and blood pressure cuff!

- Keep the blood pressure cuff out of the reach of children!

- 1) Unpack the entire delivery package and check that everything is present.
- 2) Inspect the blood pressure monitor to ensure there is no visible damage on the outside. If the blood pressure monitor is damaged, have it repaired before use.

- 3) Keep the packaging so that it can be safely packaged at a later date.

### 5.2 Inserting the batteries

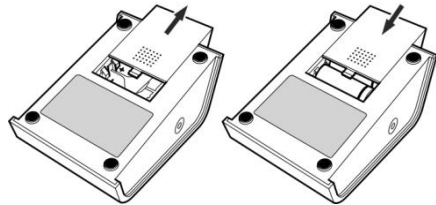

*Fig. 4: Opening the battery cover*

## Preparing the measurement

### Note

- Insert the batteries while holding the blood pressure monitor in your hand.
- Take care not to activate the button on the front!
- By pressing the button when inserting the batteries, you will enter the pressure gauge mode used for servicing purposes. Remove the batteries and insert the batteries again.

- 1) Open the battery cover on the underside of the blood pressure monitor.
- 2) Insert four batteries (AA, alkaline), with the poles aligned correctly.
- 3) Close the battery cover.  
⇒ The blood pressure monitor switches on automatically, carries out a display test and displays the start screen. (see Fig. 5 and Fig. 6).



### WARNING

Make sure that all segments are displayed by the screen. Inform your healthcare provider if the display is damaged.



Fig. 5: Test screen

### 5.3 Switching the blood pressure monitor on/off

#### Switching on



Fig. 6: Start screen

- 1) Press the  button.  
⇒ The display shows the start screen (Fig. 6).

#### Switching off

- 2) The blood pressure monitor switches off automatically after about 5 minutes.

## Measuring blood pressure and pulse

### 6 Measuring blood pressure and pulse

#### 6.1 Before measuring

- Choose the right cuff size. The blood pressure cuff size is printed on the cuff.
- Avoid eating, smoking or any strenuous activity directly before the measurement. All these factors affect the results. Before measuring your blood pressure, you should relax in a quiet atmosphere for 5 minutes.
- Always measure on the same arm (normally your left).
- Blood pressure changes over the course of the day. Measurements are only comparable when they are measured at the same time of day and under the same circumstances.

#### 6.2 Putting the blood pressure cuff on



#### **WARNING**

Risk of injury due to incorrectly connected air hose!

- Do not kink, knot or stretch the air hose.



#### **WARNING**

The blood pressure monitor must only be operated with the original blood pressure cuff, since otherwise there is a danger of incorrect measurements or injury!

**! WARNING**

Danger of injury as a result of allergic reactions to the cuff material!

- In the event of pain or allergic reaction, remove the cuff.
- Follow the instructions on cleaning and disinfection (see chapter 9)

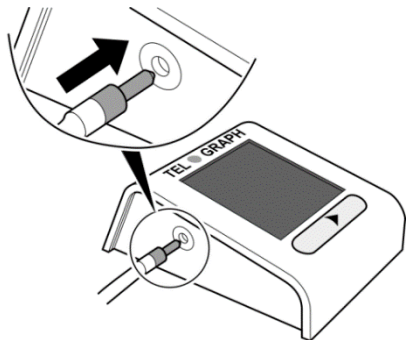

Fig. 7: Insert air hose

### Measuring blood pressure and pulse

- 1) Insert the air hose connection into the air hose socket on the left side of the blood pressure monitor and place the blood pressure monitor on the table (see fig. 7).
- 2) Select the correct cuff size. This depends on the upper arm circumference of the person whose blood pressure you will be measuring:

Upper arm circumference	Cuff size
20 – 24 cm (7.9-9.5 in)	S
24 – 32 cm (9.5-12.6 in)	M
32 – 38 cm (12.6-15.0 in)	L
38– 55 cm (15.0-21.7 in)	XL

**► Note**

To obtain accurate blood pressure readings, it is very important that the correct cuff is used.

- 3) Uncover your left upper arm.

## Measuring blood pressure and pulse

### ► Note

The blood pressure cuff must be directly against your skin.

- 4) Insert your left arm into the blood pressure cuff.

### ► Note

Blood pressure cuffs are supplied preassembled. If the cuff is not preassembled, please assemble as follows:

- Spread the cuff out with the Velcro fastening facing downwards.
- One end of the cuff features a clasp. Pass the opposite end of the cuff through the clasp, then fold it back over the clasp so that the two sides of the Velcro fastening meet.

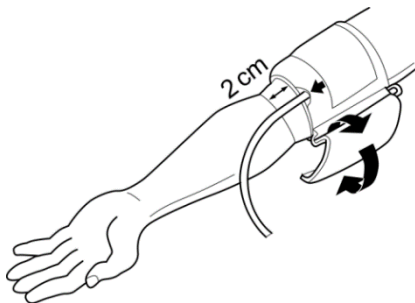

*Fig. 8: Correct position of blood pressure cuff*

- 5) Position the blood pressure cuff correctly (see Fig. 8):

- The hose must run down the middle of the inside of your lower arm towards your middle finger.
- The lower edge of the cuff must be about 2 cm (0.8 in) above your elbow.
- The artery marking (arrow above the hose) must be pointing downwards on the middle of the inside of your arm.



- 6) Once the blood pressure cuff is positioned correctly, fasten the end with the Velcro.

► **Note**

Place the blood pressure cuff so that there is enough room to insert your index and middle fingers between the skin and the material of the blood pressure cuff.

**6.3 Correct posture**

After positioning the blood pressure cuff, assume the correct posture to take the measurements (Fig. 9).

EN

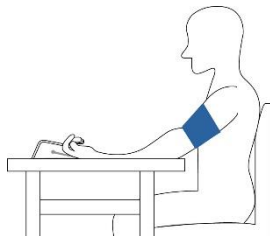

*Fig. 9: Correct posture*

- 1) Sit down comfortably on a chair to measure your blood pressure.
- 2) Place your elbow on a table or a solid surface.
- 3) Lean back in your chair.
- 4) Hold your arm so that the blood pressure cuff is at the same height as your heart.

## Measuring blood pressure and pulse

- 5) Relax your arm and turn the palm of your hand to face upwards.
- 6) Place your feet flat on the floor and leave your legs uncrossed.

### ► Note

The reading can be affected by the position of the cuff, the patient's correct posture and position, physical exertion or the patient's mental state.



## 6.4 Measuring



### WARNING

Risk of injuries during measurement!

- Do not place the air hose around your neck.
- If you feel any pain during the measurement, stop the measurement.
- Do not place the blood pressure cuff over wounds.

- 1) Apply the blood pressure cuff and assume the correct posture.
- 2) Press the  button.  
⇒ The display shows the start screen (Fig. 6).
- 3) Press the  button again to start the measurement.  
⇒ The blood pressure monitor will confirm this with a short acoustic signal and briefly displays the display functions. The blood pressure cuff slowly pumps up. The fitting pressure is displayed on the display. After the initial pumping, there is additional pumping. Once the blood pressure monitor detects

a pulse, the icon ♥ appears. The reading is taken as the air is let out. The blood pressure monitor confirms the end of the measuring with a short acoustic signal.

**Note**

Do not talk during the measurement.

You can stop the measurement at any time by pressing the  button.

- ⇒ After the measurement, all the air is let out of the blood pressure cuff. The display shows your blood pressure and your pulse rate.
- 4) Remove the blood pressure cuff.

**WARNING**

Taking measurements too frequently can result in disruptions to blood flow!

Wait for at least 2 or 3 minutes to give your arteries time to return to their initial state.

**6.5 Stopping the measurement**

- 1) If the measurement causes you pain, press the  button during the measurement.
- ⇒ The air is let out of the blood pressure cuff and the measurement is cancelled.
- 2) Remove the blood pressure cuff.

## **7 Transferring the measured values via mobile communications network**

If the blood pressure monitor is set up for transmission of your measurement values via a mobile communications network, the measurement values will be automatically transferred to the database.

If previous measurement transmissions have not yet been transferred, all data not yet sent will be sent together.

The blood pressure monitor emits a short acoustic signal to confirm successful transmission of the reading.

### **Note**

- In case of problems with transmission errors, please refer to chapter 12 "Error messages". If there is still a transmission problem, please contact your healthcare provider.
- In the event of transmission problems if there are more than 350 readings, the oldest data is overwritten by the new readings in the blood pressure monitor.

## 8 Memory

### 8.1 Saving readings



Fig. 10: Number of readings

The blood pressure monitor can save 350 blood pressure readings and 350 pulse rate readings.

#### ► Note

Only readings that have not yet been transferred to the database are saved.

If there are more than 350 readings, the oldest data will be overwritten by the new readings.

#### ! ATTENTION

##### Data loss

- If there are 10 measurements on the display, you will see a permanent error code, please contact your healthcare provider.
- Pressing the  button again will clear the warning of the error code and you can continue with your measurement.
- To avoid data loss, contact your healthcare provider before or when the display shows 350 measurements.

The number of readings is shown on the display (Fig. 10).

#### ► Note

Previously transmitted data is retained in the database and is not overwritten.

## Memory

### 8.2 Deleting readings from the blood pressure monitor

To clear the memory on your blood pressure monitor, proceed as follows:

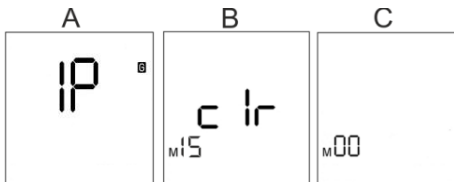



Fig. 11: Delete measurements

- 1) Press and hold the  button on the blood pressure monitor for about 3 seconds.  
⇒ The display shows [IP] (see Fig. 11A).



#### Note

The display automatically shows each menu entry for 3 seconds. The display order is:

- Mobile network transmission (IP)
- Infra-red transmission (IR)
- Delete measurements (c Ir)

#### Note

The menu options "Mobile network transmission (IP)" and "Infra-red Transmission (IR)" are provided for servicing purposes and you do not need to use it.

- 2) Wait until [c Ir] flashes on the display (Fig. 11 C).
- 3) Press the  button.  
⇒ You will hear an acoustic signal and the display will be shown [c Ir] permanently.
- 4) Press and hold the  button for more than 3 seconds.  
⇒ The acoustic signal sounds 3 times and the display shows [M00] (see Fig. 11/C).

The measurements are deleted. The device returns to standby mode and displays the *start screen* (see Fig. 6).

## 9 Cleaning and disinfection



### WARNING

- When putting the blood pressure monitor on, there must no longer be any disinfectants on the blood pressure cuff!
- There are patients who have intolerances (e.g. allergies) to disinfectants or its components!



### ATTENTION

- Do not immerse the cuff with balloon and blood pressure monitor in disinfectant, water or other liquids!
- If liquid nevertheless penetrates the device, switch it off immediately and send it away to be checked by the manufacturer or healthcare provider!
- Do not open the housing of the Tel-O-Graph® GSM, otherwise any warranty becomes void.



### Note

Always observe the manufacturer's instructions on the disinfection and cleaning of these products.

EN

## 9.1 Cleaning



### ATTENTION

- To clean, use lukewarm water up to 30 °C at most, to which you can add a mild detergent if necessary. (Never use abrasive or solvent-based detergents as these can damage the surface of the blood pressure monitor and the cuff.)
- Do not use fabric softeners or other additives (e.g. hygiene rinses, textile deodorants). These agents can leave behind residues and damage the material.
- The cuff can be washed in the washing machine up to 30°C using a mild detergent without spin-dry.
- The cuff is not suitable for drying in a dryer.
- The Velcro strip must always be closed before washing.

## Cleaning and disinfection

### Cleaning the Tel-O-Graph® GSM:

To clean the blood pressure monitor, use a damp cotton wool pad with a mild laundry detergent. Do not use any other cleaning materials.

### Cleaning the cuff sleeve:

To clean the cuff sleeve, use a mild fabric softener-free laundry detergent and lukewarm water. Do not use any other cleaning materials.

### Cleaning the bladder and hose:

The bladder needs to be removed from the cuff sleeve before cleaning. To remove the bladder, pull the end of the cuff out of the clasp and spread the cuff out fully.

Remove the bladder and hose by pulling the bladder out of the bladder compartment via the slit provided for this purpose on the inside of the cuff.

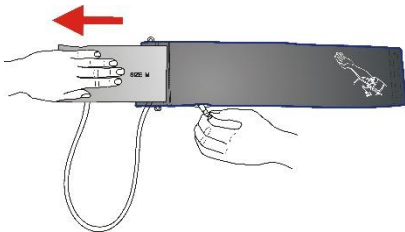

### ! ATTENTION

- To clean the bladder and hose, use a mild fabric softener-free laundry detergent and lukewarm water. Do not use any other cleaning materials.
- Ensure that no water gets into the bladder or hose.

Once the cuff, hose and bladder are completely dry, spread the cuff sleeve out with the Velcro fastening facing downwards. Insert the bladder into the bladder compartment via the slit provided and thread the hose through the small opening on the inside of the cuff. Ensure there are no folds or creases in the bladder.

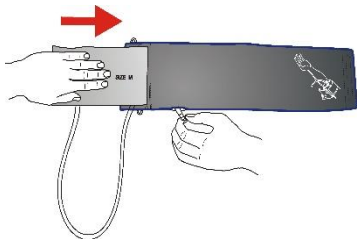





### **ATTENTION**

- Ensure that the bladder is the correct size for the cuff sleeve.
- The cuff sleeve size is shown on the outside of the cuff.

Ensure that any used disinfectants are washed off, leaving no residues, before the blood pressure cuff is worn.

## **9.2 Disinfection**

Ask your doctor if and when the cuff needs to be disinfected for hygienic reasons.

IEM GmbH has tested the following means for the disinfection:

- Isopropanol (70%)
- Terralin Liquid (Manufacturer: Schülke & Mayr)

When using other disinfectants not checked by IEM GmbH, the user is responsible for the proof of use without damage.

Never use disinfectants which leave residue on the product or which are not suitable for contact with the skin.

To achieve the optimum effect, apply the disinfectant to the cuff for at least five minutes.

Always allow the agents to dry without any residues.

### **10 Maintenance**

The monitor and the cuff are calibrated by the manufacturer for a period of two years. Maintenance (metrological check) must be carried out in accordance with Directive 93/42/EEC every two years at the latest if the device is used professionally. In certain countries, this requirement may be regulated by national laws or regulations.

The metrological check comes at an additional cost and can be carried out in Germany by either **IEM GmbH**, a competent authority or by authorised maintenance services corresponding to the "Medizinprodukte-Betreiber-Verordnung" (Medical Product Operator Regulations).

Other than the metrological check, no further electromagnetic compatibility-related maintenance is required.

## 11 Disposal

### Blood pressure monitor



The symbol on the product or packaging means that this product should not be treated as normal domestic waste, but has to be taken to a recycling point for electric and electronic devices.

You can find out more about this from your local authority, the communal disposal companies or the shop in which you bought the product.

### Batteries

Batteries must not be disposed of with domestic waste. As a consumer you are legally bound to return used batteries. You can return your old batteries to official collection points within your community or everywhere batteries of that type are sold.

	Li	Battery contains lithium
	Al	Battery contains alkali
	Mn	Battery contains manganese

## Error messages

### 12 Error messages

#### 12.1 Blood pressure measurement errors

The blood pressure monitor indicates blood pressure measurement errors and communication errors by emitting 12 short acoustic signals.

Error description	Cause	Remedy
Err 1	Arm moved during measurement.	Keep your arm still during the measurement ( → Chapter 6.3).
	Insufficient valid pulse rate detected.	Put the blood pressure cuff on again ( → Chapter 6.2).
Err 2	Arm moved during measurement.	Keep your arm still during the measurement ( → Chapter 6.3).
	The blood pressure cuff is not correctly positioned on your arm.	Check the placement of the blood pressure cuff ( → Chapter 6.2).
Err 3	Blood pressure beyond the measurement range.	If this notification appears continuously (or repeatedly), it is possible that the blood pressure monitor is not suitable for you. Contact your doctor.
	Strong arm movement.	Keep your arm still during the measurement ( → Chapter 6.3).

Error description	Cause	Remedy
Err 4	Readings not transmitted correctly.	<p>Wait until you take another measurement. The data are then transmitted together with the new readings.</p> <p>If this error occurs repeatedly, send the blood pressure monitor to your healthcare provider or directly to the manufacturer for checking.</p>
Err 5 	Power pack or battery voltage too low.	Change the batteries ( → <i>Chapter 5.2</i> ).
	Battery contacts are corroded.	Clean the battery contacts with a cotton cloth and a little alcohol.
Err 6	Air congestion	Check the blood pressure cuff for air congestion or a kink in the air hose. If there is a kink in the air hose, unkink it, otherwise send the blood pressure monitor to your healthcare provider or the manufacturer.
	Blood pressure cuff incorrectly connected.	Connect the blood pressure cuff to the blood pressure monitor ( → <i>Chapter 6.2</i> ).
	Leak in the blood pressure cuff or air hose	Replace the blood pressure cuff with the air hose.

## Error messages

<b>Error description</b>	<b>Cause</b>	<b>Remedy</b>
Abr. (Abort)	Measurement cancelled on request	Do not press this button when measuring, unless you want to abort the measuring.
Err 9	Residual pressure in the blood pressure cuff	Wait until the blood pressure cuff has deflated completely.
Err 10	Internal error	If this error occurs repeatedly, send the blood pressure monitor to your healthcare provider or directly to the manufacturer for checking.

## 12.2 Communication error

Error description	Cause	Remedy
Cod 1	Registration with mobile network not possible	Move to a location with better mobile network reception. If this error occurs repeatedly, contact your healthcare provider.
Cod 2	No GSM connection	Move to a location with better mobile network reception. If this error occurs repeatedly, contact your healthcare provider.
Cod 3	Could not send readings	Take another measurement and check whether the readings are transmitted. If this error occurs repeatedly, contact your healthcare provider.
Cod 4	Communication error	If this error occurs repeatedly, contact your healthcare provider.
Cod 5	Invalid target data in EEPROM (memory)	If this error occurs repeatedly, contact your healthcare provider.
Cod 6	Hardware communication error	If this error occurs repeatedly, contact your healthcare provider.
Cod 7	Memory empty	If this error occurs repeatedly, contact your healthcare provider.
Cod 8	Currently not used	

## *Error messages*

<b>Error description</b>	<b>Cause</b>	<b>Remedy</b>
Cod 9	SIM card not inserted	Insert the SIM card for the device.
Cod 10	Other GSM errors	If this error occurs repeatedly, contact your healthcare provider.



## 13 Technical data and symbols

### Technical data

The blood pressure monitor complies with the EMC directives.

The blood pressure cuff and air hose are made of a non-conductive material. This makes the device defibrillator-safe.

EN









Specification	Value	Unit
Measuring method	Oscillometric	
Blood pressure measurement range	Systolic 60 to 290 Diastolic 30 to 195	mmHg
Pulse measurement range	30 to 240	1/min
Pressure accuracy	+/- 3	mmHg
Pulse Rate Accuracy	±2% or ±3 BPM, whichever is greater	
Memory	350	Measurements
Power supply	6V (4x AA, 1.5V, alkaline)	
Dimensions (L x W x H)	152 X 110 X 57	Mm
Weight (without batteries)	325	G
Material (housing)	ABS (acrylonitrile-butadiene-styrene)	

### *Technical data and symbols*





<b>Specification</b>	<b>Value</b>	<b>Unit</b>
Material (cuff)	Polyester	
Operating temperature	+5 to +40	°C
Ambient pressure	700 to 1060	hPa
Transport temperature	-25 to +70	°C
Storage temperature	-25 to +70	°C
Air humidity, not condensing (operation, transport and storage)	15 to 93	%
Battery capacity	c. 200*	Measurements
Data connection	Mobile communications network	
Data transmission	GPRS Class 12	

\*in the case of 2 measurements per day with quality batteries (alkaline)

Symbols

Symbol	Meaning
	4 x LR6 or HR6, AA with 1.5 V
	Manufacturer
	Date of manufacture YYYY-MM-DD
	Designation of the FCC radio authorisation
	CE 0044: Labelling of a medical device in accordance with directive 93/42/EEC
	It may not be possible to use the device everywhere in Europe.
	Protect from rain and moisture
	Comply with the operating manual

## Technical data and symbols

Symbol	Meaning
	The symbol on the product or packaging means that this product should not be treated as normal domestic waste, but should be taken to a recycling point for electric and electronic devices. You can find out more about this from your local authority, the communal disposal companies or the shop in which you bought the product.
	Device is defibrillator-safe
	The device emits electromagnetic waves.
	Global system for mobile communication
	Serial number

## 14 Warranty and repairs

### Warranty information

- **IEM GmbH** provides a two-year warranty on the blood pressure monitor from the date of sale. Proof of the date of sale shall be provided in the form of a properly completed warranty card or an invoice.
- Faults due to material or production defects shall be remedied free of charge within the warranty period.
- A warranty claim does not result in an extension of the warranty period, neither for the device nor for the replaced components.
- The following are excluded from the warranty:
  - ⇒ All damage caused by improper handling, e.g. as a result of failing to comply with the operating manual.
  - ⇒ Damage resulting from maintenance or intervention by the purchaser or unauthorised third parties.
  - ⇒ Transport damage en route from the manufacturer to the consumer or during shipment to customer services
  - ⇒ Accessory parts subject to normal wear and tear (cuff, batteries, etc.)

- Liability for direct or indirect consequential damages caused by the device is excluded even in the event that the damage to the device is acknowledged as a warranty case.
- Any further claims, irrespective of the cause, are excluded.

**IEM GmbH** does not grant any warranty on the batteries provided.



#### ATTENTION

Do **not** open the casing.

- Once the device is opened, all warranties will lapse.

### Repairs

If the device has functional errors, please contact our customer service department who will also inform you about shipping procedures.

## Manufacturer's EMC guidelines

### 15 Manufacturer's EMC guidelines

#### Electromagnetic interference emissions

The Tel-O-Graph® GSM is intended to be operated in the electromagnetic environment specified below. Only use the Tel-O-Graph® GSM in such an environment.

Measurement of interference emissions	Compliance	Electromagnetic environment — guidelines
RF interference emissions according to CISPR 11	Group 1	The Tel-O-Graph® GSM uses RF power exclusively for its internal function. Its RF emission is therefore very low and it is unlikely that any neighbouring electronic device will experience any interference.
RF interference emissions according to CISPR 11	Class B	The Tel-O-Graph® GSM is suitable for use in facilities other than residential areas and those directly connected to the public supply network which also supplies buildings used for residential purposes.
RF interference emissions according to CISPR 25	Not applicable	
IEC 61000-3-2	Not applicable	
IEC 61000-3-3	Not applicable	

## Electromagnetic immunity

The Tel-O-Graph® GSM is intended to be operated in the electromagnetic environment specified below. Only use the Tel-O-Graph® GSM in such an environment.

Measurement of interference emissions	IEC 60601-1 test level	Compliance level	Electromagnetic environment – guidelines
Electrostatic discharge (ESD) in accordance with IEC 61000-4-2	+/- 8kV contact discharge +/- 15kV air discharge	+/- 8kV contact discharge +/- 15kV air discharge	Floors should consist of wood or cement or ceramic tiles. If the floor consists of synthetic materials, relative humidity must be at least 30%.
RF radiated disturbances in accordance with IEC 61000-4-3	10 V/m 80 MHz to 2.7 GHz	10 V/m	Do not use wearable or portable radio equipment closer to the Tel-O-Graph® GSM or its cables than the recommended safe distance.  The field strength of stationary radio wireless transmitters should be lower than the compliance level at all frequencies, as shown by an on-site examination. Interference is possible in the vicinity of devices bearing the graphic symbol “non-ionising radiation”.

## Manufacturer's EMC guidelines

Measurement of interference emissions	IEC 60601-1 test level	Compliance level	Electromagnetic environment — guidelines
IEC 61000-4-4		Not applicable	
IEC 61000-4-5		Not applicable	
IEC 61000-4-6		Not applicable	
Magnetic field at supply frequency (50/60 Hz) in accordance with IEC 61000-4-8	30 A/m	30 A/m	Magnet fields at mains frequency should match the typical values found in business and hospital environments.
IEC 61000-4-11		Not applicable	



The Tel-O-Graph® GSM has been tested with the following frequencies:

Measurement of interference emissions	IEC 60601-1 test level	Compliance level
RF interference emissions according to IEC 61000-4-3	380 - 390 MHz 27 V/m; PM 50%; 18 Hz	380 - 390 MHz 27 V/m; PM 50%; 18 Hz
	430 - 470 MHz 28 V/m; (FM ±5 kHz, 1 kHz Sinus) PM; 18 Hz	430 - 470 MHz 28 V/m; (FM ±5 kHz, 1 kHz Sinus) PM; 18 Hz
	704 - 787 MHz 9 V/m; PM 50%; 217 Hz	704 - 787 MHz 9 V/m; PM 50%; 217 Hz
	800 - 960 MHz 28 V/m; PM 50%; 18 Hz	800 - 960 MHz 28 V/m; PM 50%; 18 Hz
	1700 - 1990 MHz 28 V/m; PM 50%; 217 Hz	1700 - 1990 MHz 28 V/m; PM 50%; 217 Hz
	2400 - 2570 MHz 28 V/m; PM 50%; 217 Hz	2400 - 2570 MHz 28 V/m; PM 50%; 217 Hz
	5100 - 5800 MHz 9 V/m; PM 50%; 217 Hz	5100 - 5800 MHz 9 V/m; PM 50%; 217 Hz

## Frequency bands

### 16 Frequency bands

The Tel-O-Graph® GSM uses the following frequency bands:

Transmission performance	Band designation	Range
Class 4 (+33dBm $\pm$ 2dB)	E-GSM	850 MHz
		900 MHz
Class 1 (+30dBm $\pm$ 2dB)	GSM	1800 MHz
		1900 MHz
Class E2 (+27dBm $\pm$ 3dB)	GSM 8-PSK	850 MHz
		900 MHz
Class E2 (+26dBm +3 /-4dB)	GSM 8-PSK	1800 MHz
		1900 MHz
Class 3 (+24dBm +1/-3dB)	UMTS, WCDMA FDD BdI	2100 MHz
	UMTS, WCDMA FDD BdII	1900 MHz
	UMTS, WCDMA FDD BdVIII	900 MHz
	UMTS, WCDMA FDD BdV	850 MHz
	UMTS, WCDMA FDD BdVI	800 MHz

Rev. B – 03.05.2019